



ATC 366 '16

mixed media on paper / 64 x 89 mm
set of 366 atc's
2016

an Artist Trading Card per day keeps a guy insane



ABOUT

ATC's are miniature works of art, 2.5 per 3.5 inches, supposed to be traded between artists as a small demonstration of the creators artwork.

367

A T

Q



RUTA DE DON

QUIJOTE



0015



9100



0018

BARBER







CIPREST 0022

1860-1926

0023

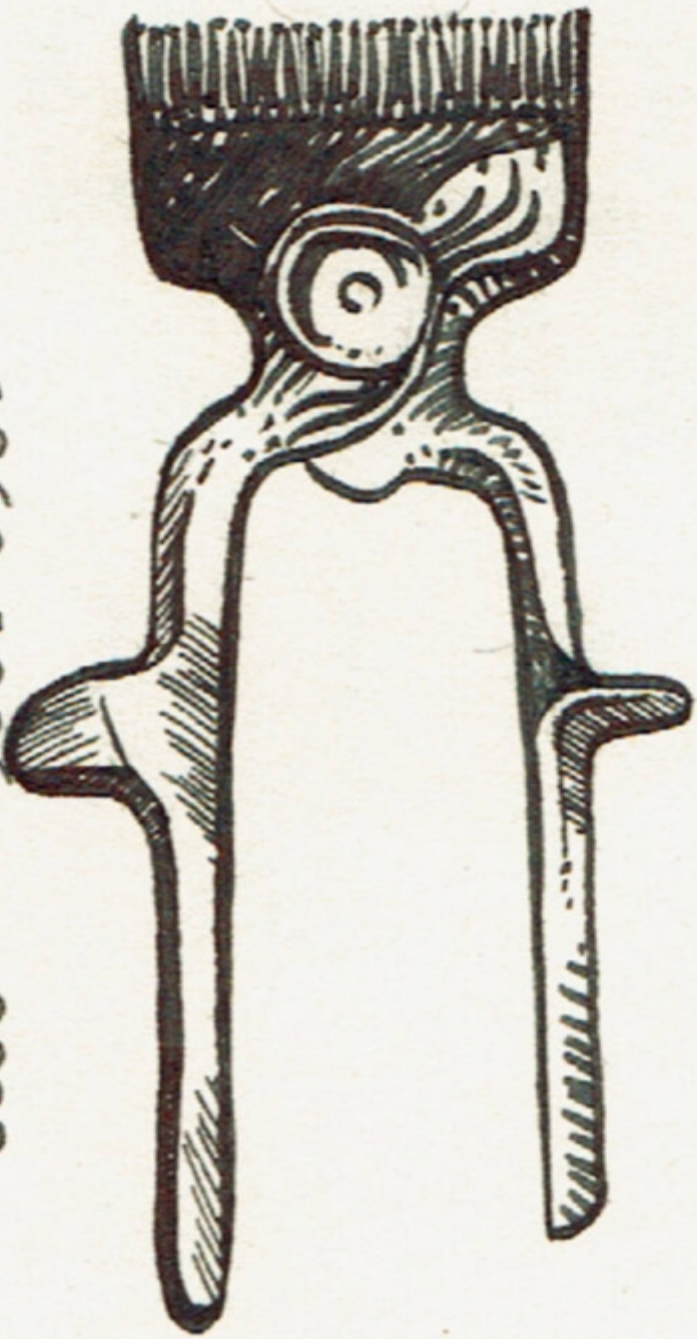

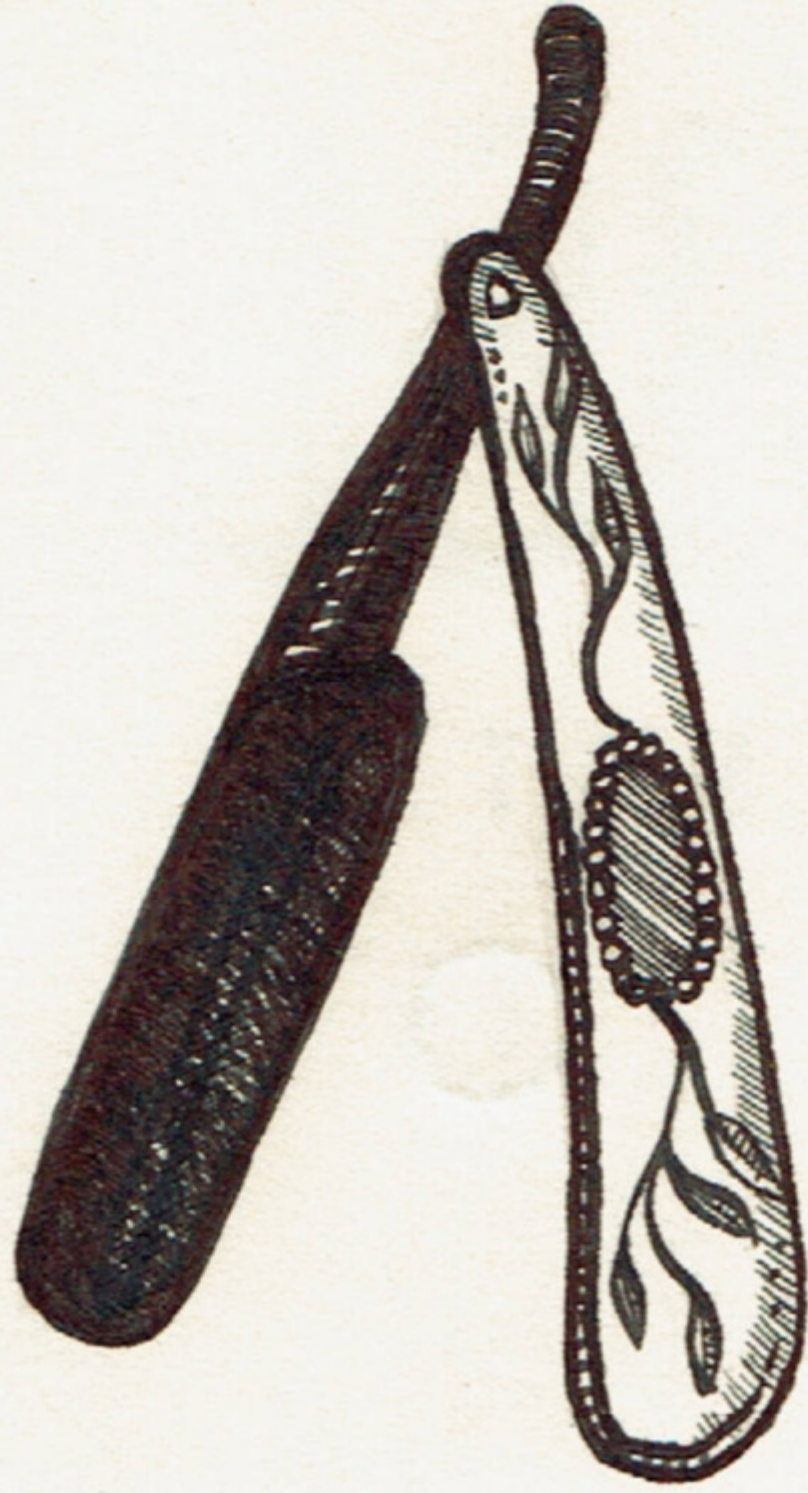

1860-1926 0024





CYPRESS 0025

002500 00

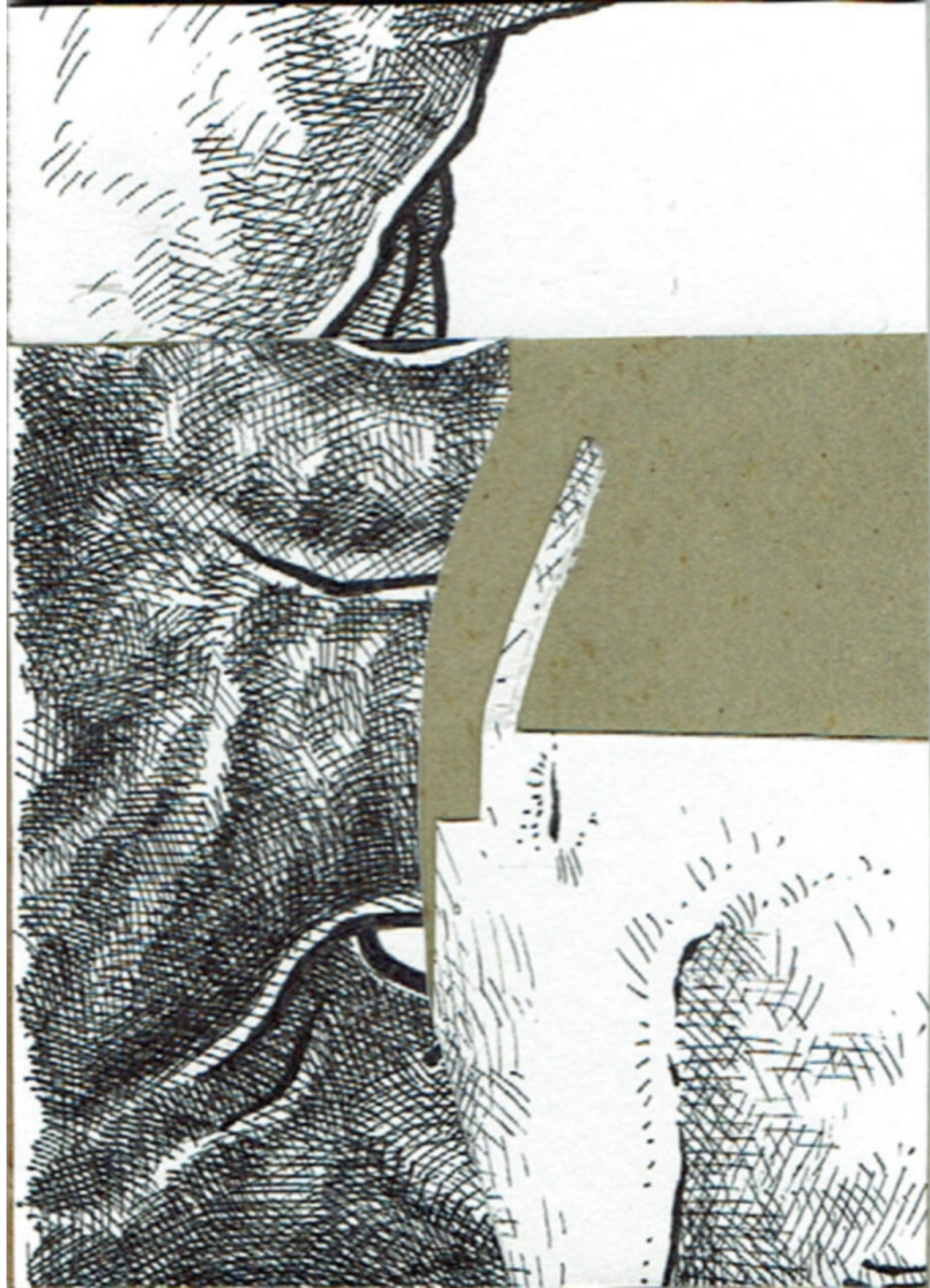

weather is so hot as hell

The trip down was ok. We

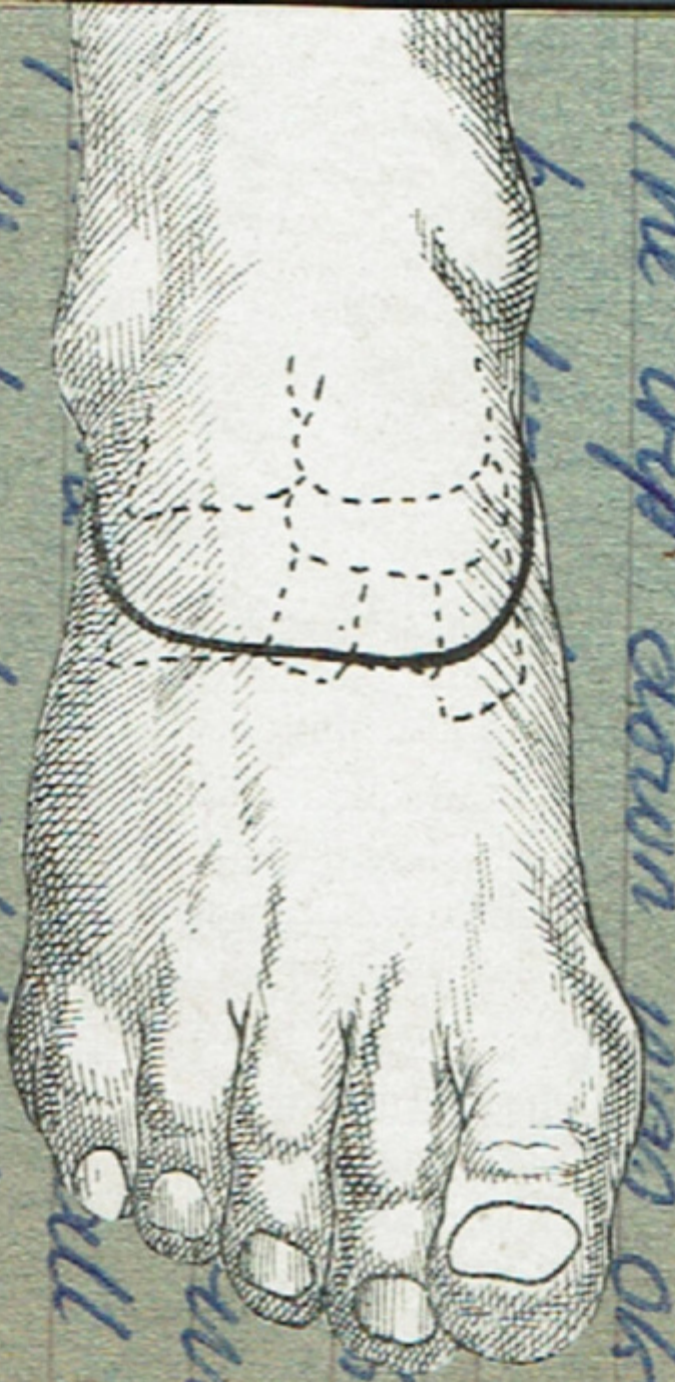

all day
very
hot
due

that end, celebrating.

Till 4 Pete carried Em to





5 606345 045000





X. 1871 s. Ja'n de castellan.



metro









HD 2304634

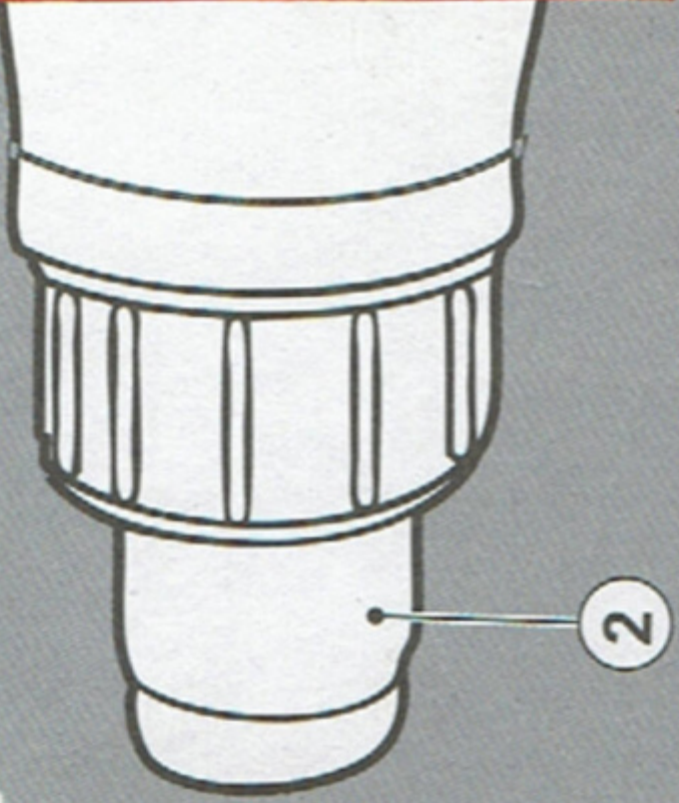

www.blackanddecker.com

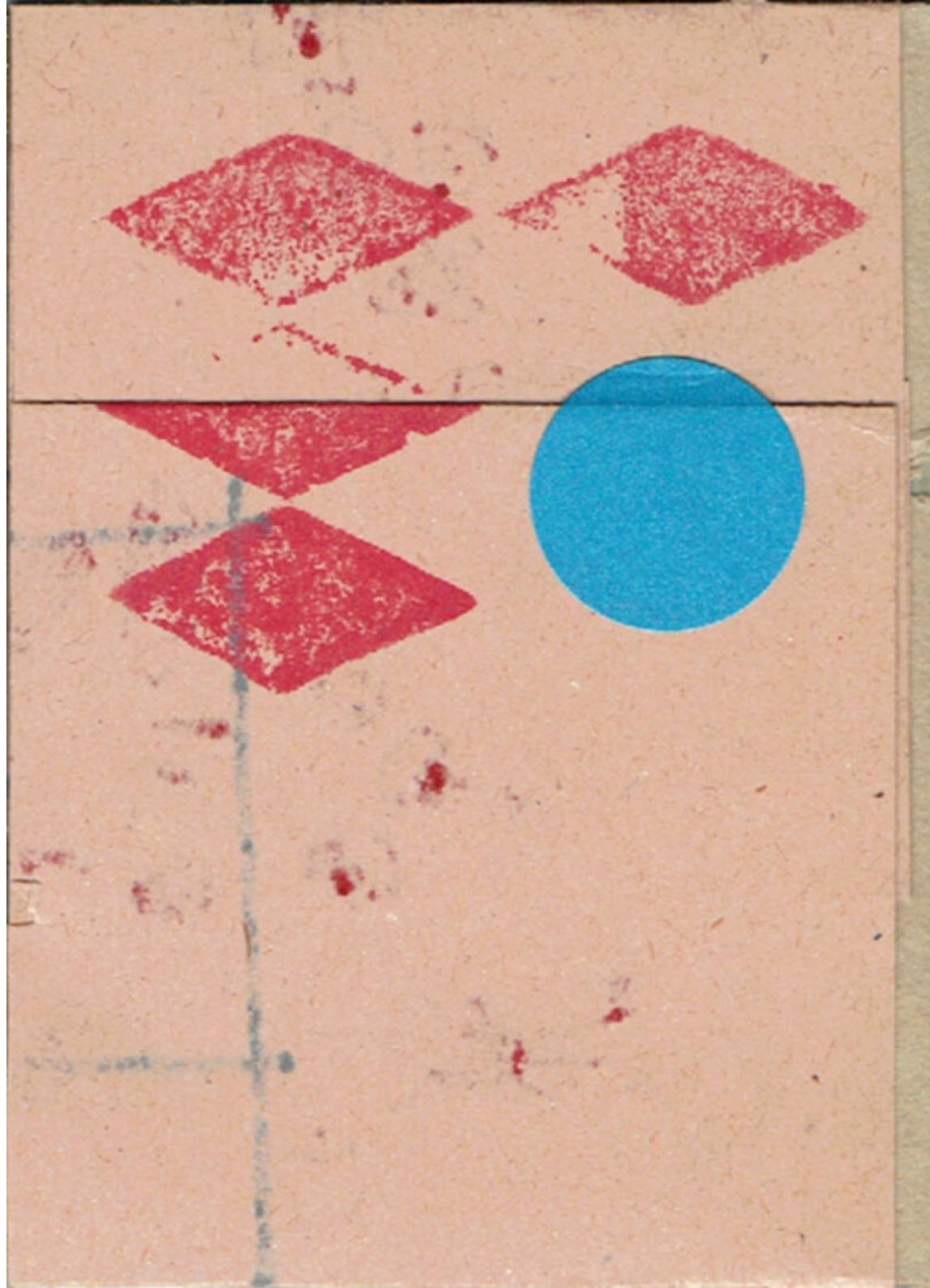





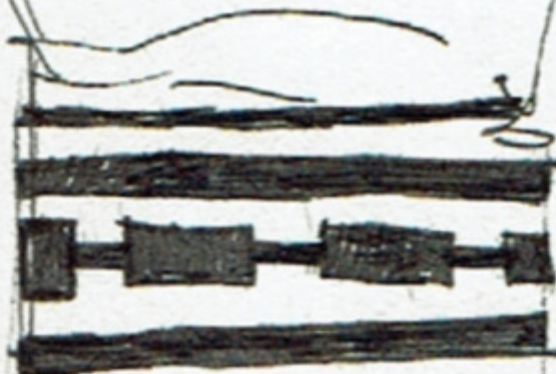

NOIR
BLUE
NOIR
ROUGE

YELLOW

ORANGE

VOLET

GREEN

YELLOW



GREEN P

BLUE

GREEN P







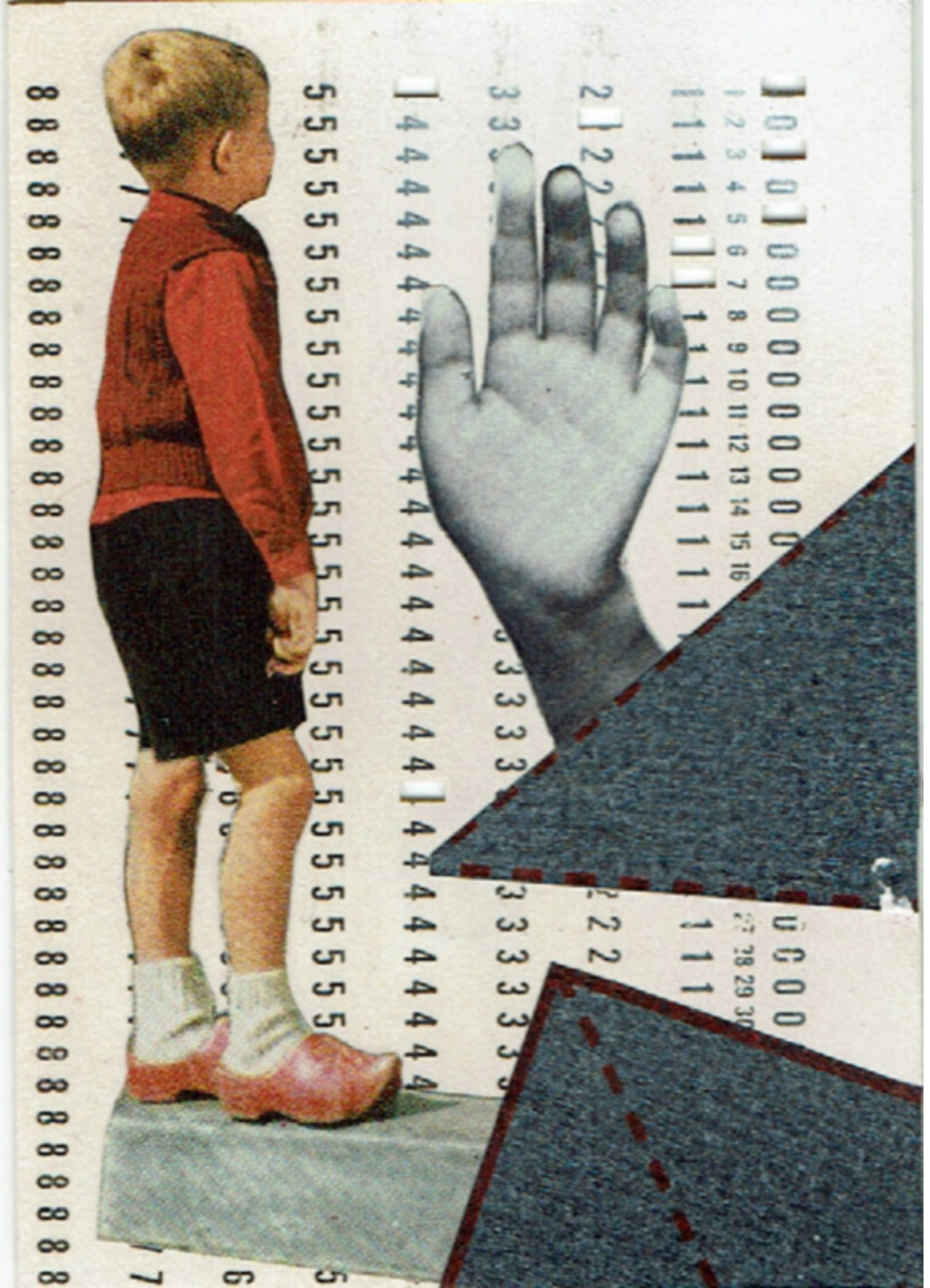



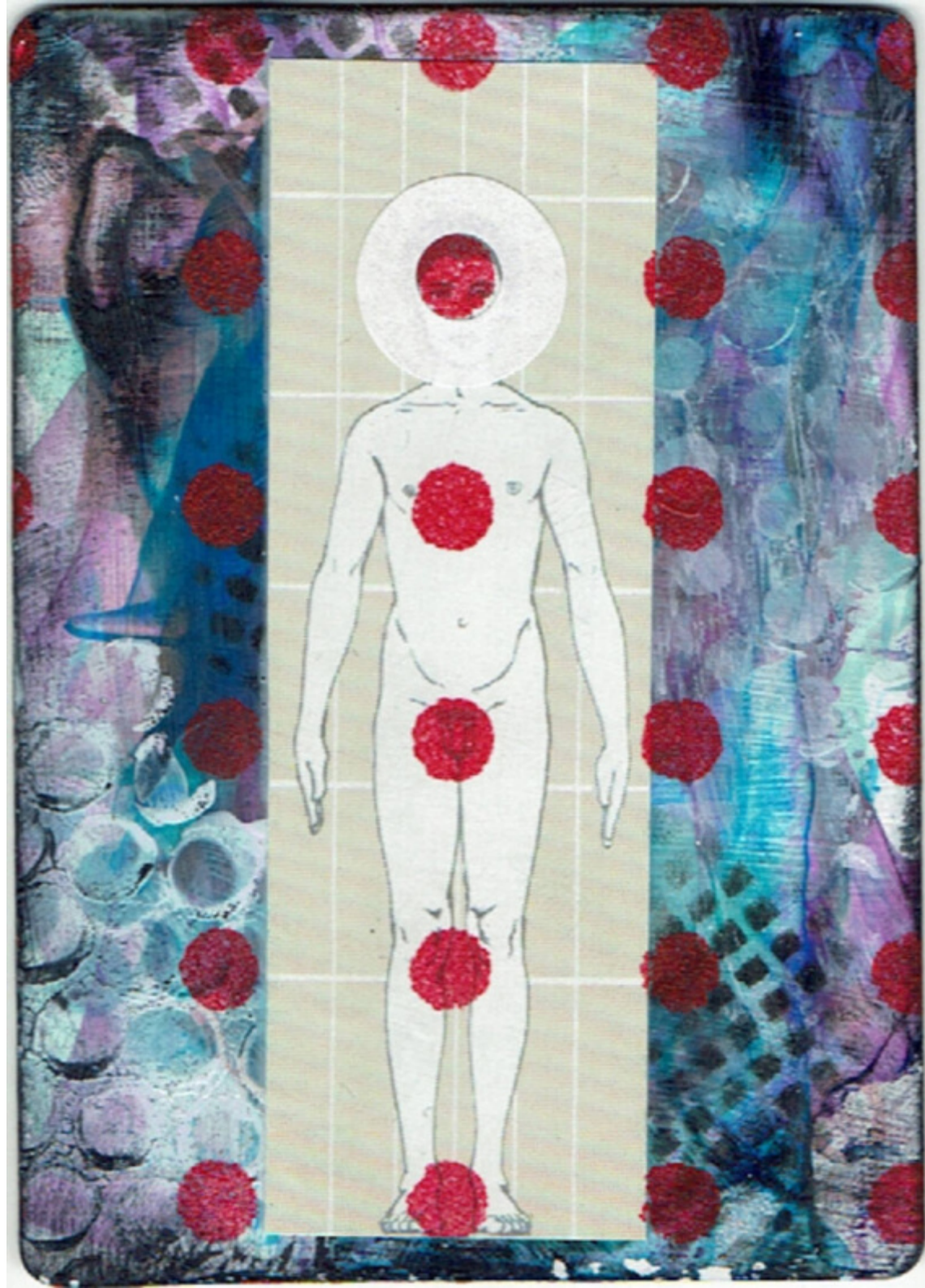

Voyez comme, en effet, son regard s'illumine :
Lune de miel, luis sur Pierre et Colomb !





















EMMA
EMMA
EMMA
EMMA

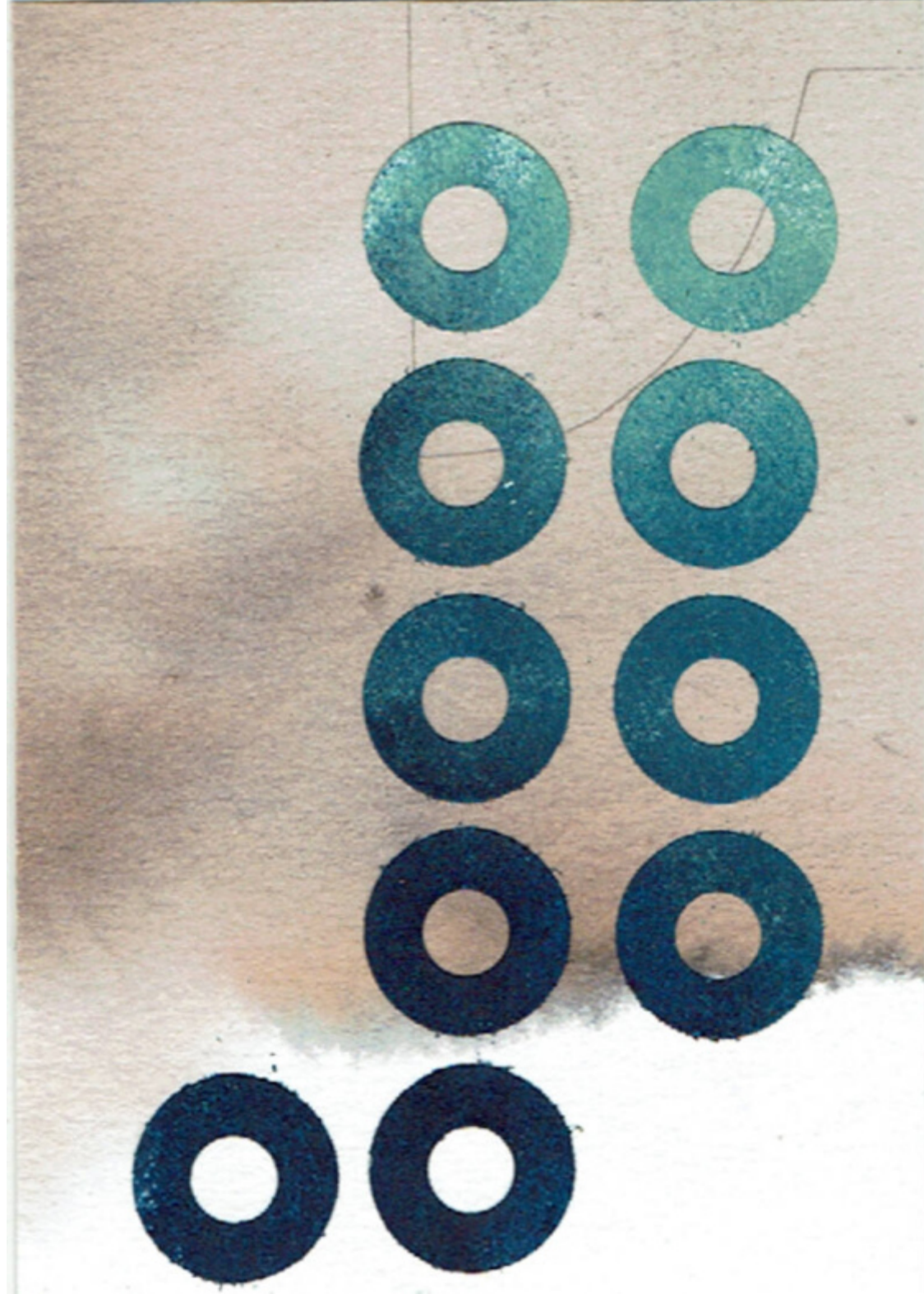







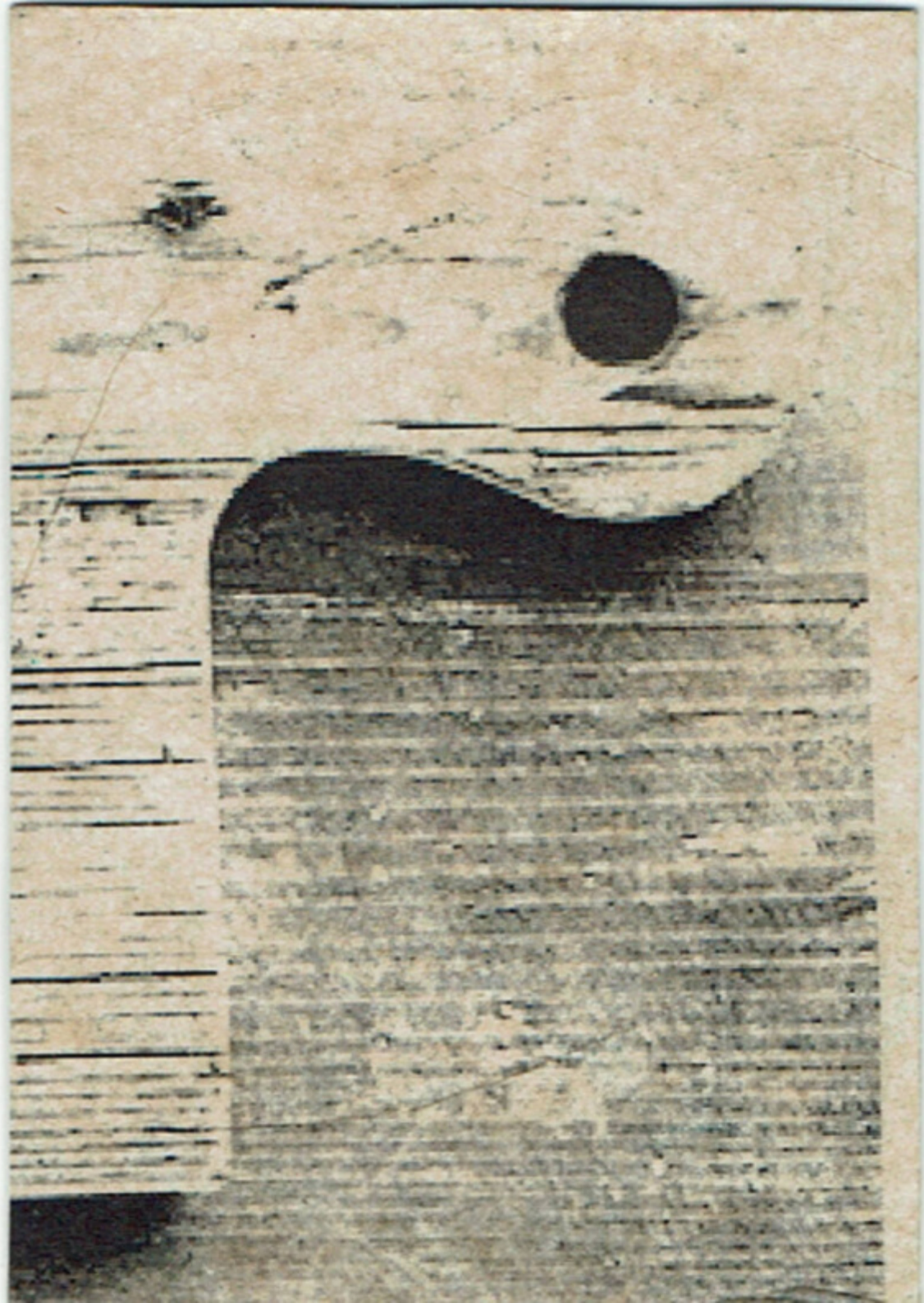





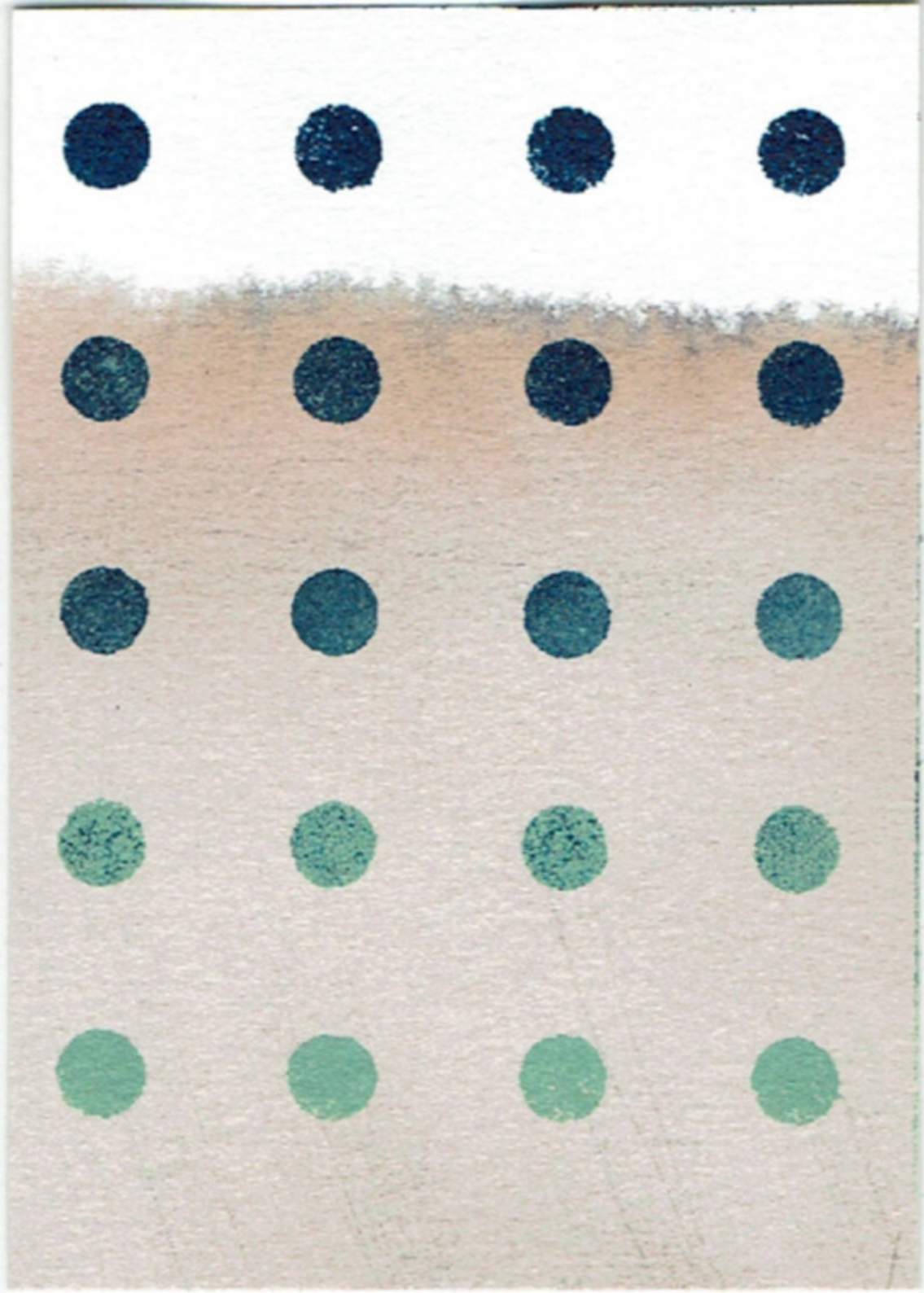



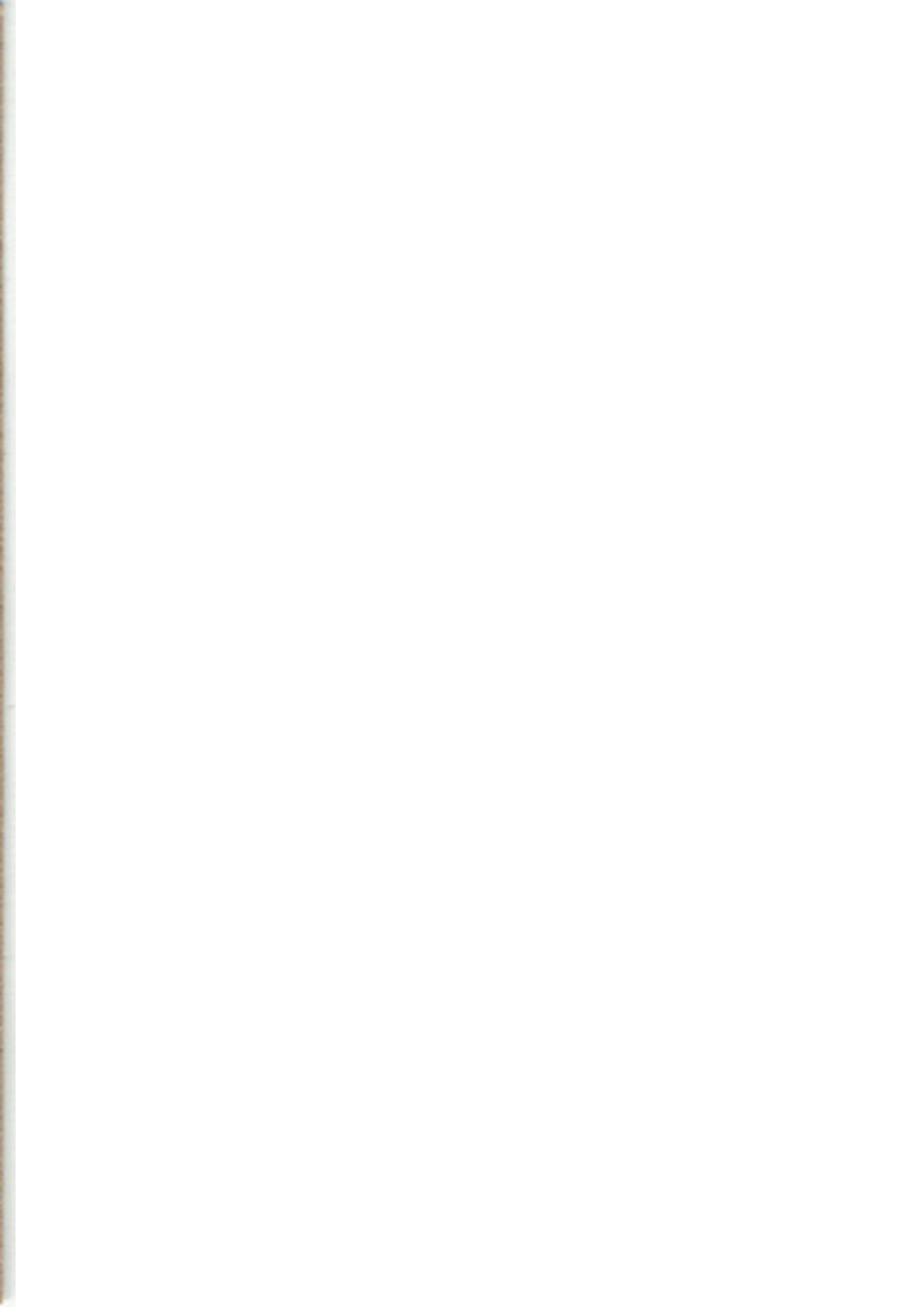



RAIDER

- 1 one unique ATC created per day every leap year adding up to 366 ATCs in total
- 2 the theme will be set every week and unique ATCs will be created using that same theme
- 3 each theme will be selected on the previous Saturday as the week is understood to start on Sundays
- 4 it's most certain that both first and last week of said year will have less than seven days
- 5 the theme will be a randomly chosen word from a book
- 6 online word generators can be used only if no book is readily available
- 7 whenever possible a video, of the act of choosing a theme, should be made
- 8 themes will be chosen by Monsenhor enVide neFelibata and Erin S. Young alternately
- 9 small words such as "a", "an", "to" and similar won't be used and if there is any doubt, the above-listed persons can decide on it
- 10 literal translations into the artists' native language and even their poetic and homonyms meanings can come into play
- 11 the same word can't be used more than once, even though it could eventually have been randomly selected multiple times
- 12 in case of randomly selecting a picture from a book, that picture will be scanned and must be used on each of those weeks ATCs at its original scale
- 13 furthermore, if a picture has come into play, a word must be chosen from another book that contains no pictures such as dictionaries and both picture and word will be set as the theme
- 14 all online publications must be made using the hashtag #atc366_2016 [#atc366_YEAR]

GALLERY



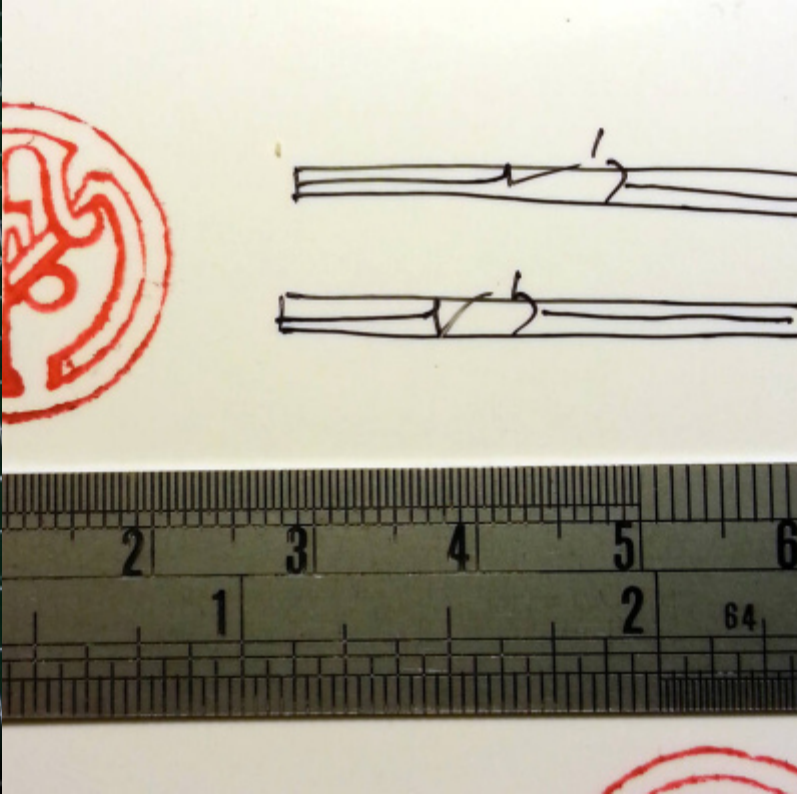

SHOWN AT

2018

"ATC366++" // Biblioteca Municipal José Marmelo Silva / Espinho, Portugal

